



ICPLW50L

DESCRIPTION

The ICPLW50L 1MBd digital optocoupler consists of a high efficient AlGaAs Light Emitting Diode and a high speed optical detector. The output of the optical detector features an open collector Schottky clamped transistor. The internal shield ensures high common mode transient immunity.

The device is in Stretched SO6 package.

FEATURES

- High speed – 1MBd typical
- Stretched SO6 Package
- Wide Operating Voltage Range
V_{CC} 2.7V to 24V
- Low Drive Current 3mA
- Package Clearance / Creepage 8mm
- 15kV/μs Minimum Common Mode Rejection at V_{CM} = 1500V
- Guarantee Performance over Temperature Range: -40°C to 105°C
- TTL Compatible
- Open collector output
- Lead Free and RoHS Compliant
- Safety Approvals Pending

APPLICATIONS

- Digital Signal Isolation
- Communications Interface
- Micro-controller Interface
- Digital Isolation for A/D, D/A Conversion
- Switching Power Supplies

ORDER INFORMATION

- Supplied in Tape and Reel

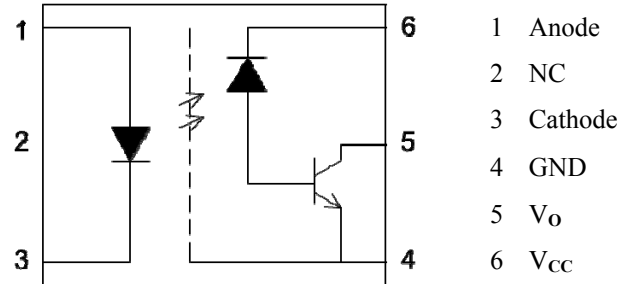

A 0.1μF bypass Capacitor must be connected between Pins 6 and 4.

ABSOLUTE MAXIMUM RATINGS

T_A = 25°C unless otherwise specified.

Stresses exceeding the absolute maximum ratings can cause permanent damage to the device.

Exposure to absolute maximum ratings for long periods of time can adversely affect reliability.

Input

Forward Current	20mA
Forward Peak Current (Pulse Width = 1ms, 50% Duty Cycle)	40mA
Forward Peak Transient Current (Pulse Width = 1μs, 300pps)	1.0A
Reverse Voltage	5V
Power dissipation	36mW

Output

Output Collector Current	8mA
Peak Output Current	16mA
Supply Voltage	-0.5 to 30V
Output Collector Voltage	-0.5 to 20V
Power Dissipation	100mW

Total Package

Isolation Voltage	5000V _{RMS}
Operating Temperature	-40 to 105 °C
Storage Temperature	-55 to 125 °C
Lead Soldering Temperature (10s)	260°C

ISOCOM COMPONENTS 2004 LTD

Unit 25B, Park View Road West, Park View Industrial Estate
Hartlepool, Cleveland, TS25 1UD, United Kingdom
Tel: +44 (0)1429 863 609 Fax : +44 (0)1429 863 581
e-mail: sales@isocom.co.uk
<http://www.isocom.com>

ISOCOM COMPONENTS ASIA LTD

Hong Kong Office,
Block A, 8/F, Wah Hing Industrial mansion,
36 Tai Yau Street, San Po Kong, Kowloon, Hong Kong.
Tel: +852 2995 9217 Fax : +852 8161 6292
e-mail sales@isocom.com.hk



ICPLW50L

Truth Table

LED	V _o
OFF	HIGH
ON	LOW

Recommended Operating Conditions

Parameter	Symbol	Min	Max	Unit
Operating Temperature	T _A	- 40	105	°C
Supply Voltage	V _{CC}	2.7	24	V
Input Current (ON)	I _{FH}	3	10	mA
Input Voltage (OFF)	V _{F(OFF)}		0.8	V



ICPLW50L

ELECTRICAL CHARACTERISTICS ($V_{CC} = 2.7$ to $24V$, $I_F = 3mA$ and $T_A = -40^\circ C$ to $105^\circ C$, unless otherwise specified)

INPUT

Parameter	Symbol	Test Condition	Min	Typ.	Max	Unit
Forward Voltage	V_F	$I_F = 3mA$	1.2	1.4	1.8	V
Reverse Voltage	V_R	$I_R = 10\mu A$	5			V

OUTPUT

Parameter	Symbol	Test Condition	Min	Typ.	Max	Unit
High Level Supply Current	I_{CCH}	$I_F = 0mA$, $V_{CC} = 30V$, $V_O = \text{Open}$, $T_A = 25^\circ C$			2	μA
Low Level Supply Current	I_{CCL}	$I_F = 3mA$, $V_{CC} = 30V$ $V_O = \text{Open}$		60	100	μA
High Level Output Current	I_{OH}	$I_F = 0mA$, $V_O = V_{CC} = 5.5V$, $T_A = 25^\circ C$			0.5	μA
		$I_F = 0mA$, $V_{CC} = 30V$, $V_O = 20V$, $T_A = 25^\circ C$			1	
		$I_F = 0mA$, $V_{CC} = 30V$, $V_O = 20V$			80	
Low Level Output Voltage	V_{OL}	$I_F = 3mA$, $V_{CC} = 3.3V$ or $5V$, $I_O = 3mA$, $T_A = 25^\circ C$		0.25	0.4	V
		$I_F = 3mA$, $V_{CC} = 3.3V$ or $5V$, $I_O = 1.6mA$, $T_A = 25^\circ C$		0.25	0.5	

COUPLED

Parameter	Symbol	Test Condition	Min	Typ.	Max	Unit
Current Transfer Ratio	CTR	$I_F = 3mA$, $V_{CC} = 3.3V$ or $5V$, $V_O = 0.4V$, $T_A = 25^\circ C$	90	125	200	%
		$I_F = 3mA$, $V_{CC} = 3.3V$ or $5V$, $V_O = 0.5V$,	53			



ICPLW50L

ELECTRICAL CHARACTERISTICS ($V_{CC} = 2.7$ to $24V$, $I_F = 3mA$ and $T_A = -40^{\circ}C$ to $105^{\circ}C$, unless otherwise specified)

SWITCHING

Parameter	Symbol	Test Condition	Min	Typ.	Max	Unit
Propagation Delay Time to High Output Level	t_{PLH}	$f = 10kHz$, Duty Cycle = 50%, $I_F = 3mA$, $V_{CC} = 3.3V$, $R_L = 1.8k\Omega$, $C_L = 15pF$, $V_{THLH} = 2V$		0.4	1.4	μs
		$f = 10kHz$, Duty Cycle = 50%, $I_F = 3mA$, $V_{CC} = 5.0V$, $R_L = 2.9k\Omega$, $C_L = 15pF$, $V_{THLH} = 2V$		0.4	1	
Propagation Delay Time to Low Output Level	t_{PHL}	$f = 10kHz$, Duty Cycle = 50%, $I_F = 3mA$, $V_{CC} = 3.3V$, $R_L = 1.8k\Omega$, $C_L = 15pF$, $V_{THHL} = 1.5V$		0.3	1	
		$f = 10kHz$, Duty Cycle = 50%, $I_F = 3mA$, $V_{CC} = 5.0V$, $R_L = 2.9k\Omega$, $C_L = 15pF$, $V_{THHL} = 1.5V$		0.3	1	
Pulse Width Distortion [$t_{PHL} - t_{PLH}$] for any given device	PWD	$f = 10kHz$, Duty Cycle = 50%, $I_F = 3mA$, $V_{CC} = 3.3V$, $R_L = 1.8k\Omega$, $C_L = 15pF$, $V_{THLH} = 2V$ $V_{THHL} = 1.5V$		0.1	1.4	
		$f = 10kHz$, Duty Cycle = 50%, $I_F = 3mA$, $V_{CC} = 5.0V$, $R_L = 2.9k\Omega$, $C_L = 15pF$, $V_{THLH} = 2V$ $V_{THHL} = 1.5V$		0.1	1	
Common Mode Transient Immunity at High Output Level	CM_H	$I_F = 0mA$, $V_{CC} = 3.3V$ or $5V$, $V_{CM} = 1500V$ p-p $R_L = 1.8k\Omega$ or $2.9k\Omega$, $T_A = 25^{\circ}C$	15			$kV/\mu s$
Common Mode Transient Immunity at Low Output Level	CM_L	$I_F = 3mA$, $V_{CC} = 3.3V$ or $5V$, $V_{CM} = 1500V$ p-p, $R_L = 1.8k\Omega$ or $2.9k\Omega$, $T_A = 25^{\circ}C$	15			$kV/\mu s$



ICPLW50L

ELECTRICAL CHARACTERISTICS ($V_{CC} = 2.7$ to $24V$, $I_F = 3mA$ and $T_A = -40^{\circ}C$ to $105^{\circ}C$, unless otherwise specified)

ISOLATION

Parameter	Symbol	Test Condition	Min	Typ.	Max	Unit
Insulation Voltage	V_{ISO}	$t = 1$ min, $T_A = 25^{\circ}C$, $RH \leq 50\%$,	5000			V
Input - Output Resistance	R_{I-O}	$V_{I-O} = 500VDC$		10^{12}		Ω
Input - Output Insulation Leakage Current	I_{I-O}	$V_{I-O} = 3kVDC$, $t = 5s$, $T_A = 25^{\circ}C$, $RH 45\%$,			1.0	μA

Note :

1. A 0.1 μF bypass capacitor must be connected across pin 6 and pin 4.
2. CM_H , Common Mode Transient Immunity in High stage is the maximum tolerable positive dV_{CM}/dt on the leading edge of the common mode impulse signal, V_{CM} , to assure that the output will remain high ($V_O > 2.0V$).
3. CM_L , Common Mode Transient Immunity in Low stage is the maximum tolerable negative dV_{CM}/dt on the trailing edge of the common mode impulse signal, V_{CM} , to assure that the output will remain low ($V_O < 0.8V$).



ICPLW50L

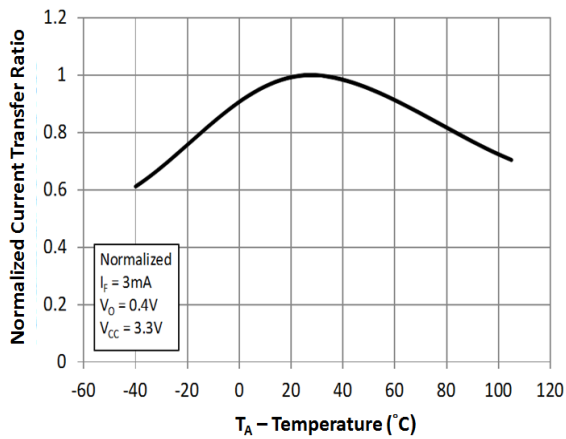

Fig 1 Normalized Current Transfer Ratio vs Ambient Temperature (Vcc=3.3V)

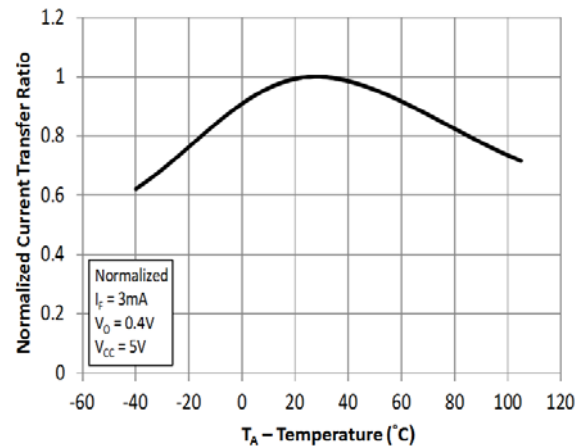

Fig 2 Normalized Current Transfer Ratio vs Ambient Temperature (Vcc=5V)

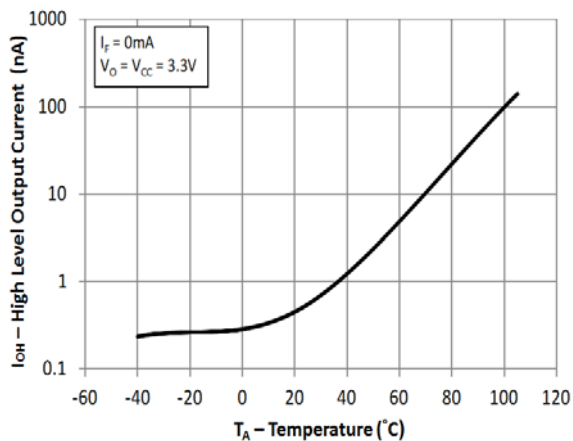

Fig 3 Typical High Level Output Current vs Ambient Temperature (Vo=Vcc=3.3V)

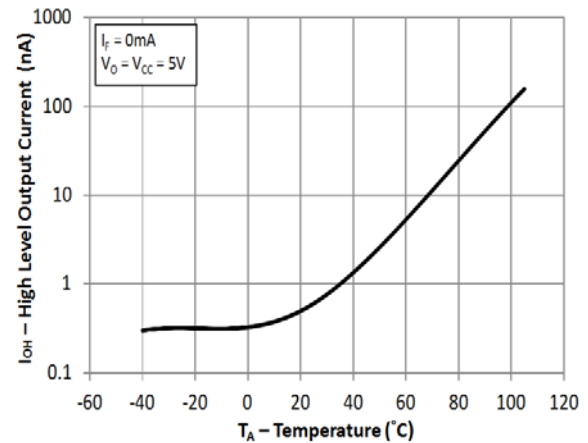

Fig 4 Typical High Level Output Current vs Ambient temperature (Vo=Vcc=5V)

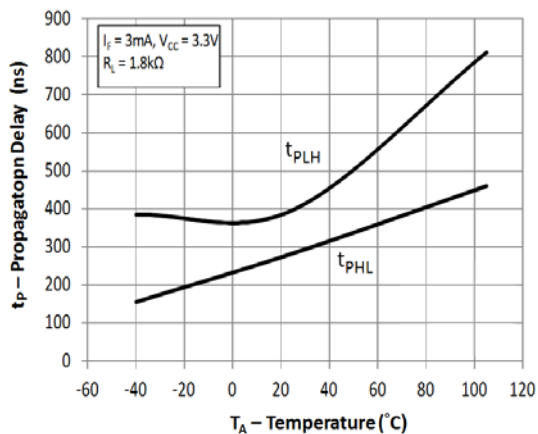

Fig 5 Typical Propagation Delay vs Ambient Temperature (Vcc=3.3V RL=1.8kΩ)

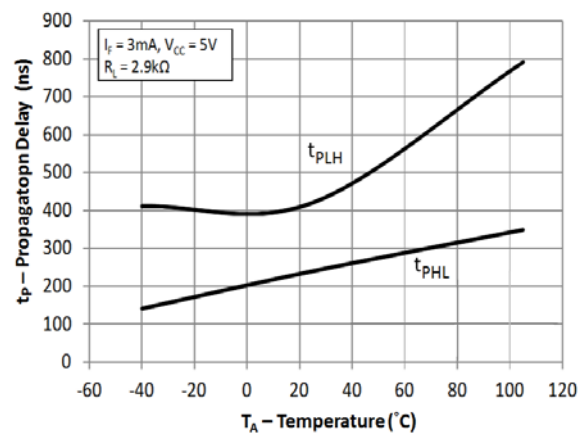

Fig 6 Typical Propagation Delay vs Ambient Temperature (Vcc=5V RL=2.9kΩ)



ICPLW50L

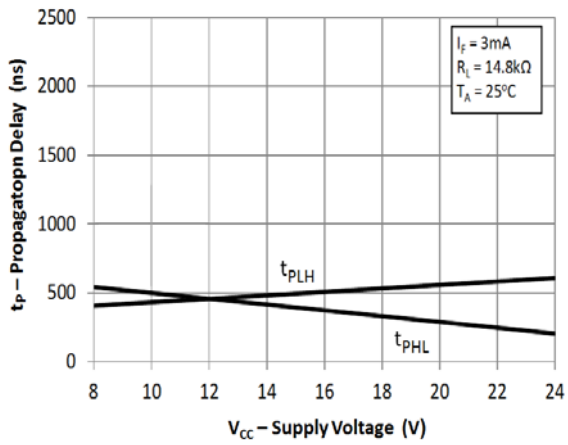

Fig 7 Typical Propagation Delay vs Supply Voltage

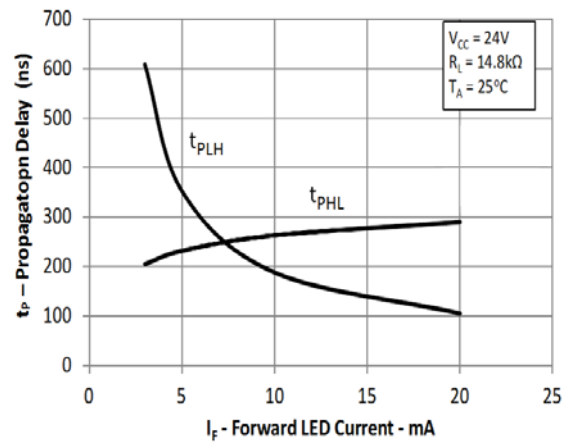

Fig 8 Typical Propagation Delay vs Forward Current

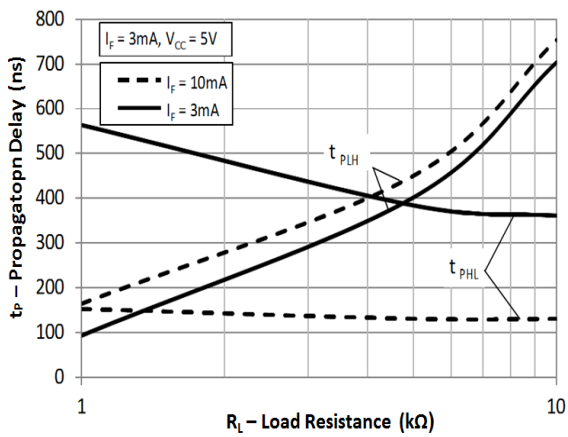

Fig 9 Typical Propagation Delay vs Load Resistance

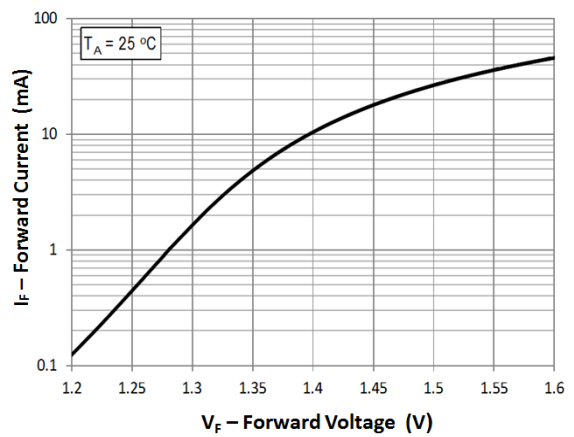
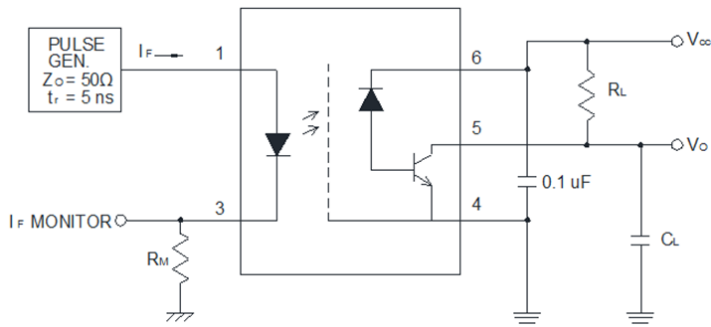

Fig 10 Forward Current vs Forward Voltage



ICPLW50L



Switching Test Circuit and Waveforms

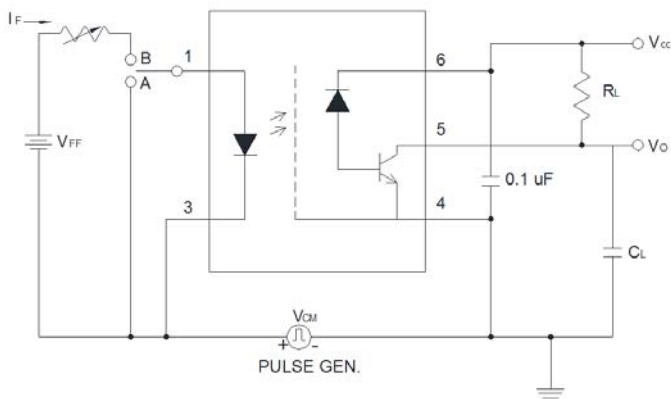

CMR Test Circuit and Waveforms



ICPLW50L

ORDER INFORMATION

ICPLW50L			
After PN	PN	Description	Packing quantity
None	ICPLW50L	Stretched SO6	1000 pcs per reel

DEVICE MARKING



W501 denotes Device Part Number
L
/ denotes Isocom
YY denotes 2 digit Year code
WW denotes 2 digit Week code



ICPLW50L

PACKAGE DIMENSIONS and Recommended PCB Pad Layout in mm (inch)

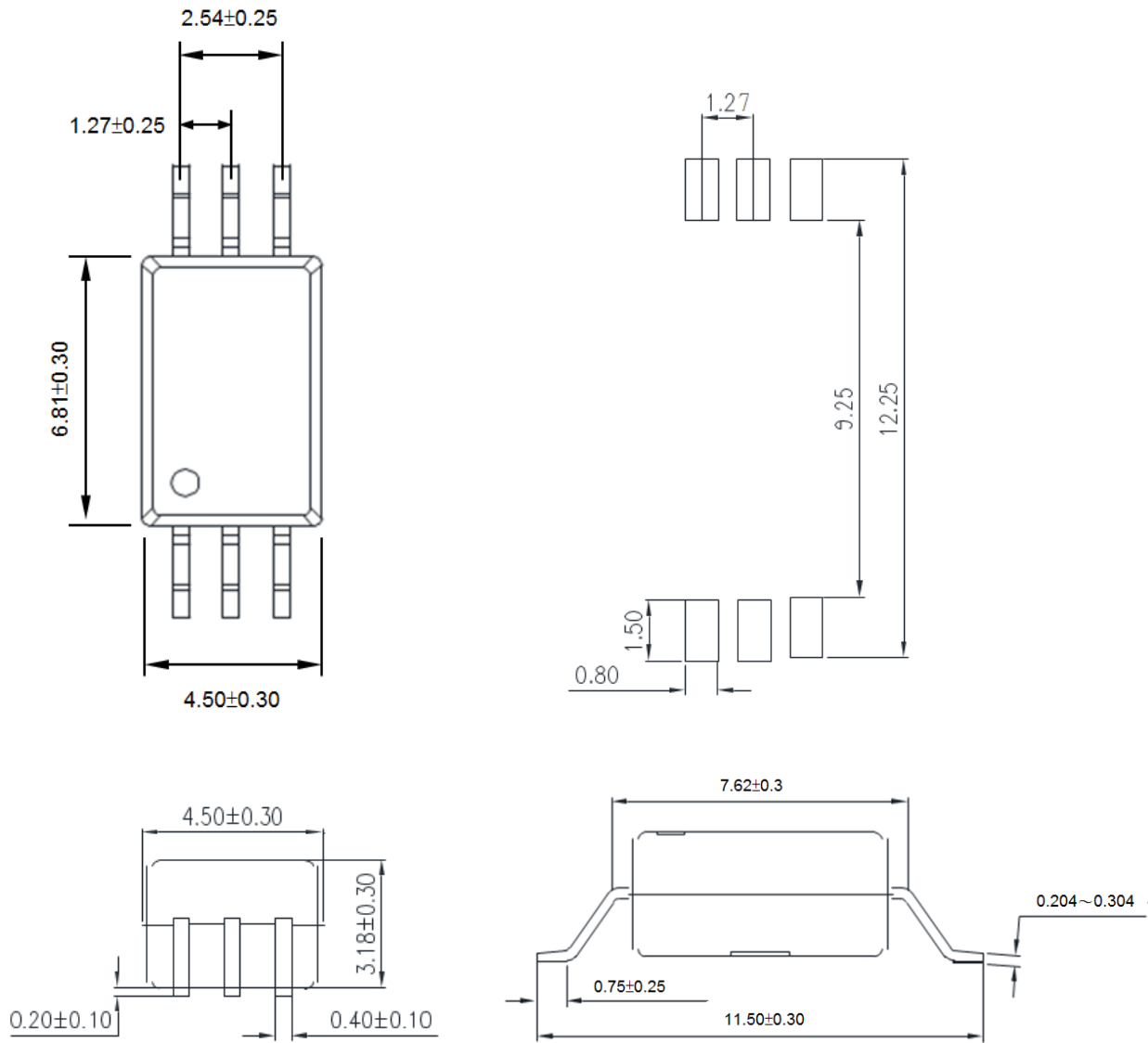



ICPLW50L

TAPE AND REEL PACKAGING

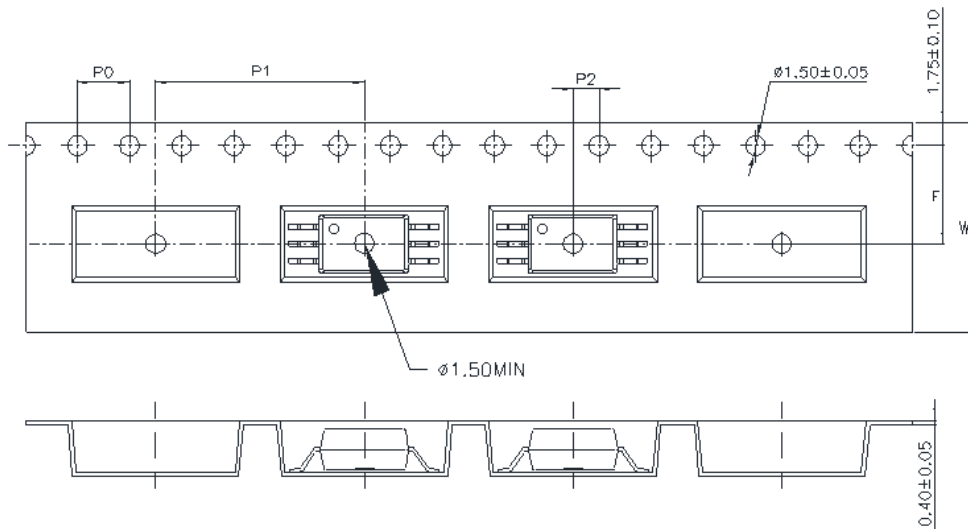

Description	Symbol	Dimension mm (inch)
Tape Width	W	16 ± 0.3 (0.63)
Pitch of Sprocket Holes	P_0	4 ± 0.1 (0.16)
Distance of Compartment to Sprocket Holes	F	7.5 ± 0.1 (0.3)
	P_2	2 ± 0.1 (0.079)
Distance of Compartment to Compartment	P_1	16 ± 0.1 (0.63)



ICPLW50L

IR REFLOW SOLDERING TEMPERATURE PROFILE
(One Time Reflow Soldering is Recommended)

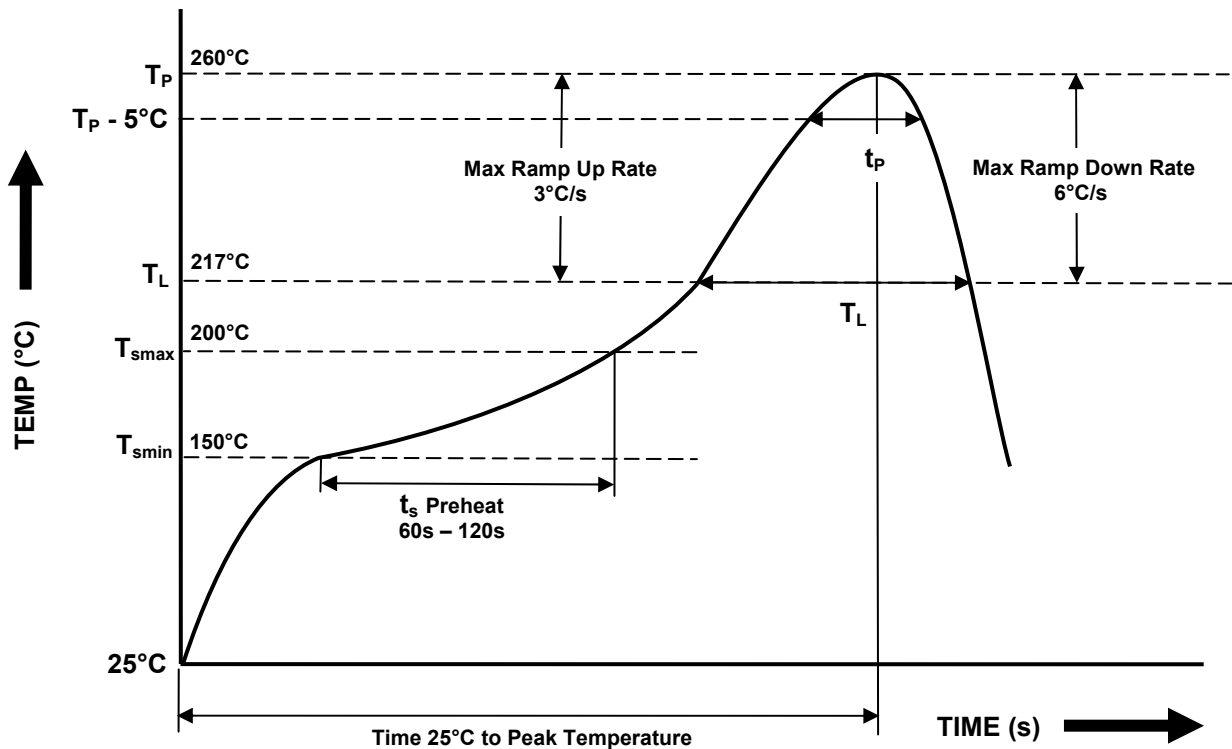

Profile Details	Conditions
Preheat - Min Temperature (T _{SMIN}) - Max Temperature (T _{SMAX}) - Time T _{SMIN} to T _{SMAX} (t _s)	150°C 200°C 60s - 120s
Soldering Zone - Peak Temperature (T _P) - Time at Peak Temperature - Liquidous Temperature (T _L) - Time within 5°C of Actual Peak Temperature (T _P - 5°C) - Time maintained above T _L (t _L) - Ramp Up Rate (T _L to T _P) - Ramp Down Rate (T _P to T _L)	260°C 10s max 217°C 30s max 60s - 100s 3°C/s max 6°C/s max
Average Ramp Up Rate (T _{smax} to T _P)	3°C/s max
Time 25°C to Peak Temperature	8 minutes max

